



DataMaster

RDM/DMX tool, cable tester, 5p XLR connectors,
pouch, charging cable, XLR adapters



USER MANUAL

Thank you for choosing PROLIGHTS

Please note that every PROLIGHTS product has been designed in Italy to meet quality and performance requirements for professionals and designed and manufactured for the use and application as shown in this document.

Any other use, if not expressly indicated, could compromise the good condition/operation of the product and/or be a source of danger.

This product is meant for professional use. Therefore, commercial use of this equipment is subject to the respectively applicable national accident prevention rules and regulations.

Features, specifications and appearance are subject to change without notice. Music & Lights S.r.l. and all affiliated companies disclaim liability for any injury, damage, direct or indirect loss, consequential or economic loss or any other loss occasioned by the use of, inability to use or reliance on the information contained in this document.

Product user manual can be downloaded from the website www.prolights.it, or can be inquired to the official PROLIGHTS distributors of your territory (https://www.prolights.it/sales_network.html).

Scanning the below **QR Code**, you will access the download area of the product page, where you can find a broad set of always updated technical documentation: specifications, user manual, technical drawings, photometrics, personalities, fixture firmware updates.



**Visit the download area
of the product page**



The PROLIGHTS Logo, PROLIGHTS names and all other trademark in this document pertaining to PROLIGHTS services or PROLIGHTS product are trademarks OWNED or licensed by Music & Lights S.r.l., its affiliates, and subsidiaries. PROLIGHTS is a registered trademark by Music & Lights S.r.l. All right reserved. Music & Lights – Via A. Olivetti, snc - 04026 - Minturno (LT) ITALY.

INDEX

SAFETY INFORMATION	02
1 - PACKAGING	05
PACKAGE CONTENT	05
OPTIONAL ACCESSORIES	05
2 - TECHNICAL DRAWING	05
3 - PRODUCT OVERVIEW	06
4 - CONNECTION TO THE POWER SUPPLY	07
5 - DMX CONNECTION	07
CONNECTION OF THE CONTROL SIGNAL: DMX LINE	07
INSTRUCTIONS FOR A RELIABLE DMX CONNECTION	07
CONNECTION DAISY CHAIN	07
CONNECTION OF THE DMX LINE	07
CONSTRUCTION OF THE DMX TERMINATION	08
DMX ADDRESSING	08
6 - CONTROL PANEL	09
DISPLAY AND BUTTONS LAYOUT	09
7 - MENU STRUCTURE	10
8 - USE	12
RDM MODE	12
AUTO ADDRESS MODE	14
STAND ALONE MODE	14
RECEIVE DMX MODE	15
LOAD SCENE MODE	15
CABLE TEST MODE	15
USING EXAMPLE	16
9 - MAINTENANCE	17
MAINTENANCE THE PRODUCT	17
VISUAL CHECK OF PRODUCT HOUSING	17
TROUBLESHOOTING	17

SAFETY INFORMATION



WARNING!

- See <https://www.prolights.it/product/DATAMASTER#download> for installation instructions.
- Please read carefully the instruction reported in this section before installing, powering, operating or servicing the product and observe the indications also for its future handling.



This unit is not for household and residential use, only professional applications.



Li-ion

Lithium-Ion Battery Maintenance Guidelines*

Lithium-Ion rechargeable batteries products require routine maintenance and care in their use and handling. Read and follow the guidelines in this document to safely use Lithium-Ion batteries and achieve the maximum battery life span.

Misusing the device battery may cause the battery to get hot, breaking, or ignite, and cause serious injury.

Overview

- Only authorised technicians may service the battery.
- Use only Prolights approved batteries in your Prolights products.
- Do not leave the device unused for extended periods of time in storage.
- Lithium-Ion batteries continue to slowly discharge (self-discharge) when not in use or while in storage. Routinely check the battery's charge status.
- The typical estimated life of a Lithium-Ion battery is about two years or around 300 charge cycles, whichever occurs first. One charge cycle is a period of use from fully charged, to fully discharged, and fully recharged again.
- For batteries that do not complete full charge cycles the life expectancy can be less than two years also.
- Rechargeable Lithium-Ion batteries have a limited life and will gradually lose their capacity to hold a charge. This loss of capacity (ageing) is irreversible. As the battery loses capacity, the length of time it will power the product (run time) decreases.

Battery Maintenance

- The run time of your battery will vary depending on the product's configuration and the applications that you run.
- Routinely check the battery's charge status.
- Carefully monitor batteries that are approaching the end of their estimated life.
- Consider replacing the battery with a new one if you note either of the following conditions:
 1. The battery run time drops below about 70% of the original run time.
 2. The battery charging time increases significantly.
- If a battery is stored or otherwise unused for an extended period, be sure to follow the storage instructions in this document.
- Always recharge immediately when the battery is low.
- If you do not follow the instructions, and the battery has no charge remaining when you check it, consider it to be damaged. Do not attempt to recharge it or to use it. Replace it with a new battery.



Charging

- **Do not charge unattended.**
- Always follow the charging instructions provided.
- It is recommended to charge at a temperature between 15°C and 35°C.
- Do not recharge the product longer than required, it will affect the battery capacity.
- Refer to your product's user manual and/or online help for detailed information about charging its battery. The latest version of your Prolights product user manual is available at www.prolights.it.

Storage

- Store the product in an airy, dry place, and away from any inflammable object in order to ensure optimum storage conditions for the battery.
- Do not expose the device battery to fire or heat.
- Charge or discharge the battery to approximately 50% of capacity before storage.
- Charge the battery to approximately 50% of capacity at least once every six months.
- Store the product at temperatures between 5 °C and 20 °C (41 °F and 68 °F).

Handling Precautions

- Do not disassemble, crush, or puncture a battery.
- Do not short the external contacts on a battery.
- Do not dispose of a battery in fire or water.
- Do not expose a battery to temperatures above 60 °C (140 °F).
- Avoid exposing the battery to excessive shock or vibration.
- Do not use a damaged battery.
- If a battery pack has leaking fluids, do not touch any fluids. Dispose of a leaking battery pack (see Disposal and Recycling in this document).
- In case of eye contact with fluid, do not rub eyes. Immediately flush eyes thoroughly with water for at least 15 minutes, lifting upper and lower lids, until no evidence of the fluid remains. Seek medical attention.

Transportation

- Always check all applicable local, national, and international regulations before transporting a Lithium-Ion battery.
- Transporting an end-of-life, damaged, or recalled battery may, in certain cases, be specifically limited or prohibited.

Disposal and Recycling

- Lithium-Ion batteries are subject to disposal and recycling regulations that vary by country and region. Always check and follow your applicable regulations before disposing of any battery. Contact your local battery recycling organization.
- Many countries prohibit the disposal of waste electronic equipment in standard waste receptacles. Place only discharged batteries in a battery collection container.
- Use electrical tape or other approved covering over the battery connection points to prevent short circuits.



Protection from burns and fire

- The exterior of the fixture becomes hot during use. Avoid contact by persons and materials.
- Ensure that there is free and unobstructed airflow around the fixture.
- Keep flammable materials well away from the fixture.
- Do not expose the front glass to sunlight or any other strong light source from any angle. Lenses can focus the sun's rays inside the fixture, creating a potential fire hazard.
- Do not attempt to bypass thermostatic switches or fuses.



Indoor use

- This product is designed for indoor and dry environments.
- Do not use in wet location and do not expose the fixture to rain or moisture.
- Never use the fixture in places subject to vibrations or bumps.
- Make certain that no inflammable liquids, water or metal objects enter the fixture.
- Excessive dust, smoke fluid, and particle build up degrades performance, causes overheating and will damage the fixture.
- Damages caused by inadequate cleaning or maintenance are not covered by the product warranty.



Maintenance

- Only technicians who are authorized by PROLIGHTS or Authorised service partners are permitted to open the fixture.
- Users may carry out external cleaning, following the warnings and instructions provided, but any service operation not described in this manual must be referred to a qualified service technician.
- Important! Excessive dust, smoke fluid, and particle build up degrades performance, causes overheating and will damage the fixture. Damages caused by inadequate cleaning or maintenance is not covered by the product warranty.



Disposal

- This product is supplied in compliance with European Directive 2012/19/EU – Waste Electrical and Electronic Equipment (WEEE). To preserve the environment please dispose/ recycle this product at the end of its life according to the local regulation.



The product contains a lithium ion battery

- Don't throw the unit into the garbage at the end of its lifetime.
- Make sure to dispose according to your local ordinances and/or regulations, to avoid polluting the environment!
- The packaging is recyclable and can be disposed.



The products to which this manual refers comply with:

- 2014/35/EU - Safety of electrical equipment supplied at low voltage (LVD).
- 2014/30/EU - Electromagnetic Compatibility (EMC).
- 2011/65/EU - Restriction of the use of certain hazardous substances (RoHS).



Other approvals

1 - PACKAGING

PACKAGE CONTENT

- 1 x DATAMASTER
- 1 x Nylon bag
- 1 x XLR adapter from 3p male to 5p female
- 1 x XLR adapter from 3p female to 5p male
- 1 x USB cable from type A to type MICRO-B
- 1 x XLR adapter from 5p to single DMX cable cable
- User Manual

OPTIONAL ACCESSORIES

- UPBOX1UP5 Firmware uploader kit, USB IN, 5pin XLR DMX OUT, USB OUT;
- TOUR53415L03: Dmx cable HC5340. CANC5MXX XLR 5p->CANC5FXX XLR (f) 5p, L.3m;
- UPBOXPRO: Firmware uploader kit, USB IN, 5-pin XLR DMX OUT connector.

2 - TECHNICAL DRAWING

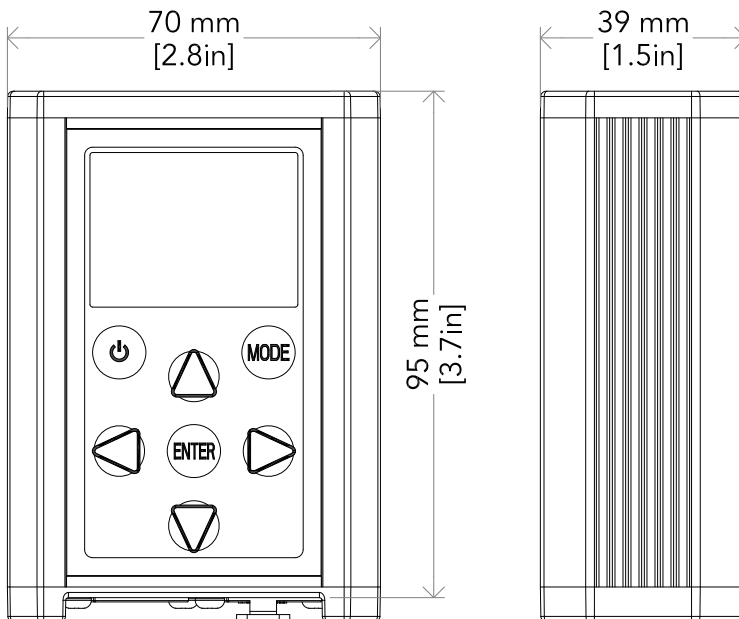

Fig. 01

3 - PRODUCT OVERVIEW

1. MICRO USB PORT for charging cable
2. CONTROL PANEL with display and 6 buttons used to access the control panel functions and manage them
3. DMX IN (5-pole XLR)
4. These connectors are used to receive an incoming; 1 = ground, 2 = DMX-, 3 = DMX+, 4 N/C, 5 N/C
5. DMX OUT (5-pole XLR)
6. These connectors are used for sending an output signal; 1 = ground, 2 = DMX-, 3 = DMX+, 4 N/C, 5 N/C

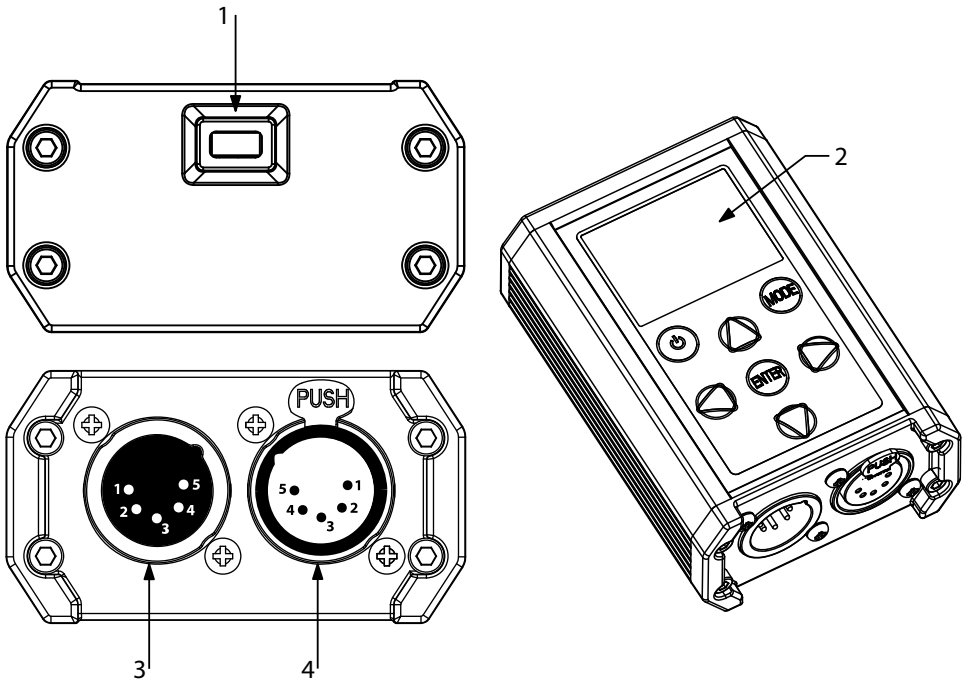

Fig 02

4 - CONNECTION TO THE POWER SUPPLY

The DATAMASTER has a rechargeable lithium battery inside, which must be charged through the micro-USB B port to a pc or a 5V max 500mA power supply (not supplied).

WARNING: Do not leave the device charging unattended and for a long time.

5 - DMX CONNECTION

CONNECTION OF THE CONTROL SIGNAL: DMX LINE

The product has XLR sockets for DMX input and output.

The default pin-out on both socket is as the following diagram:

DMX - INPUT XLR plug



Pin1 : GND - Shield
Pin2 : - Signal
Pin3 : + Signal
Pin4 : N/C
Pin5 : N/C

DMX - OUTPUT XLR socket

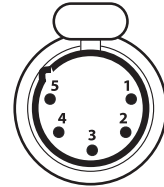

Fig. 03

INSTRUCTIONS FOR A RELIABLE DMX CONNECTION

Use shielded twisted-pair cable designed for RS-485 devices: standard microphone cable cannot transmit control data reliably over long runs. 24 AWG cable is suitable for runs up to 300 meters (1000 ft). Heavier gauge cable and/or an amplifier is recommended for longer runs.

To split the data link into branches, use splitter-amplifiers in the connection line.

Do not overload the link. Up to 32 devices may be connected on a serial link.

CONNECTION DAISY CHAIN

Connect the DMX data output from the DMX source to the product DMX input (male connector XLR) socket.

Run the data link from the product XLR output (female connector XLR) socket to the DMX input of the next fixture.

Terminate the data link by connecting a 120 Ohm signal termination. If a splitter is used, terminate each branch of the link.

Install a DMX termination plug on the last fixture on the link.

CONNECTION OF THE DMX LINE

DMX connection employs standard XLR connectors. Use shielded pair-twisted cables with 120Ω impedance and low capacity.

The following diagram shows the connection mode:

DMX Address: 33

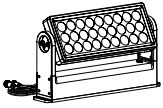

DMX Address: 43

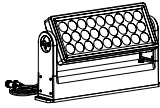

DMX Address: 53

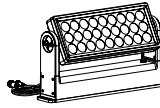

DMX Address: 63

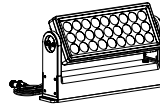

.....

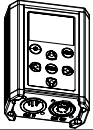

DATAMASTER

Fig. 04 - Example DMX channels configuration

CONSTRUCTION OF THE DMX TERMINATION

The termination is prepared by soldering a 120Ω 1/4 W resistor between pins 2 and 3 of the male XLR connector, as shown in figure.

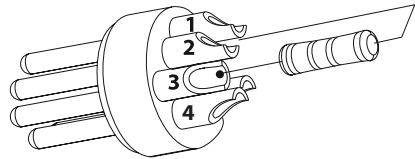
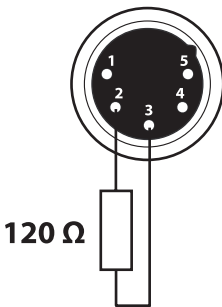

Example:
5 pin XLR connector

Fig. 05

DMX ADDRESSING

In order to start controlling the product via DMX, the first step is to select a DMX address, also known as the start channel, this is the first channel used to receive instructions from a DMX controller. If you wish to control the product individually, it is necessary to assign a different starting address channel to each fixture.

The number of channels occupied from the product depends on the DMX mode selected, so always verify the DMX Mode in the MENU before start addressing.

If you assign two fixtures the same address, they will be executing the same behaviour. Selecting the same address to multiple fixtures can be useful for diagnostic purposes and symmetrical control.

DMX addressing is limited to make it impossible to set the DMX address so high that you are left without enough control channels for the product.

To set the fixture's DMX address:

1. Press ENTER to open the main menu.
2. Reach the addressing menu, then select the DMX ADDRESS settings.
3. Select the address from 1 to 512 using the navigation arrows/buttons and confirm by pressing ENTER.
4. Press Menu to exit and return to the Home screen.

6 - CONTROL PANEL

The product has an OLED display and 6 buttons for access to the functions of the control panel.

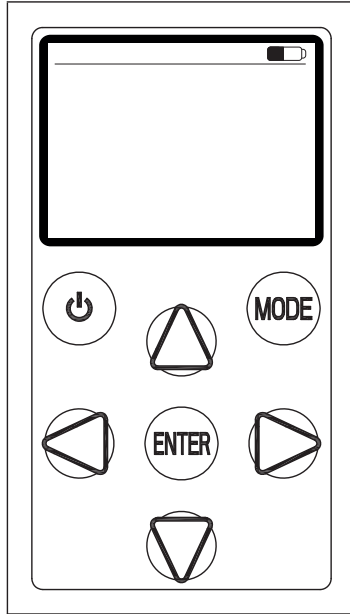









Fig. 06

DISPLAY AND BUTTONS LAYOUT

The product has a display and buttons for access to the control panel functions:

	<ul style="list-style-type: none">• UP: To scroll through the functions of the main menu or increase the value of the function.
	<ul style="list-style-type: none">• DOWN: To scroll through the functions of the main menu or decrease the value of the function.
	<ul style="list-style-type: none">• LEFT: To move left in the function.
	<ul style="list-style-type: none">• RIGHT: To move right in the function.
	<ul style="list-style-type: none">• ENTER: To enter the next menu or confirm the displayed value or to activate the function displayed.
	<ul style="list-style-type: none">• MODE: To return to the previous menu.
	<ul style="list-style-type: none">• POWER: To turn the device on and off.
	<ul style="list-style-type: none">• ICON BATTERY: Shows the battery charge status of the device.

7 - MENU STRUCTURE

The following chart describes the MENU tree of the product.

	Main Menu	Menu Level 2	Menu Level 3	Menu Level 4	Menu Level 5	Description
1	RDM	No Fixtures Found				<i>It means no fixtures found via RDM</i>
		Discovering.....				<i>Shows information about each product. Some attributes will allow changes to be made. See each individual products. User Manual to determine which attributes are controllable.</i>
		Edit Mode (Choose from the attributes unique to each)	Single/Model			
2	Auto Address	1				<i>Automatically assign dmx address. This is only for ARCSHINE M/S</i>
3	Stand Alone	Manual Color	Head1	RED	0-255	<i>Allows for standalone settings. This only for some projectors without display, for example old arcpod. Make setting on the stand-alone (ARCPD15Q, ARCPD27Q, ARCPD48Q, ARCPD96Q, ARCPD101, ARCSPT FC) (On VW devices this section is not available)</i>
				GREEN	0-255	
				BLUE	0-255	
				WHITE	0-255	
				COOL WHITE	0-255	
				WARM WHITE	0-255	
			Head2 (Only for ARCPD96Q)	RED	0-255	
				GREEN	0-255	
				BLUE	0-255	
				WHITE	0-255	
				COOL WHITE	0-255	
				WARM WHITE	0-255	
		Effects	Head1	Effects 1	0-255	
				...	0-255	
				Effects9	0-255	
Head2 (Only for ARCPD96Q)	Effects 1		0-255			
	...		0-255			
	Effects9		0-255			
4	Send DMX (512)	Edit Mode	All			<i>Edit mode for all the channels</i>
			Normal			<i>Edit mode for single channel</i>

	Show Level As	Decimal (0-255)			<i>Choose the display format for the data</i>	
		Percent (0-100)				
	Clear All Channels				<i>Clear all data</i>	
	DMX Sequence	Play Sequence				<i>Play the sequence</i>
		Edit Sequence				<i>Edit the sequence</i>
		Delete Sequence	No			<i>Keep the sequence</i>
			Yes			<i>Delete the sequence</i>
	Store Scene	Scene 1				<i>Save/store the already set DMX data to the scene</i>
		Scene 2				
		Scene 3				
		...				
		Scene 32				
	Play Scene	Scene 1				<i>Loads the scene and can be used to edit it</i>
		Scene 2				
		Scene 3				
...						
Scene 32						
5	Receive DMX	Show Level As	Decimal (0-255)			<i>Choose the display format for the data</i>
			Percent (0-100)			
	Store Scene	Scene 1				<i>Save/store the received data to the scene</i>
		Scene 2				
		Scene 3				
		...				
		Scene 32				
6	Play Scene	Scene 1				<i>Play the stored scene</i>
		Scene 2				
		Scene 3				
		...				
		Scene 32				
7	Cable Test	In	Out			<i>Test the dmx cable signal</i>
		1-()-1				
		2-()-2				
		3-()-3				
		4-()-4				
		5-()-5				
8	Power Options	Off				<i>When no operation from the datamaster, select the time to define when the datamaster will power off.</i>
		1 Minute				
		5 Minute				
		10 Minute				
9	Information	Version xx				<i>Information of DATAMASTER</i>
		UID: 15D00200 ****				

8 - USE

DATAMASTER is RDM-DMX tool that automatically detects the RDM enabled devices and allows the user to monitor and control them rapidly and effectively. The fixtures' status information such as the burning time of the lamp, can be read directly on the DATAMASTER - the user doesn't have to go to the fixture. In addition, commands can be sent via DMX channels. Extra features are cable testers and DMX recorder.

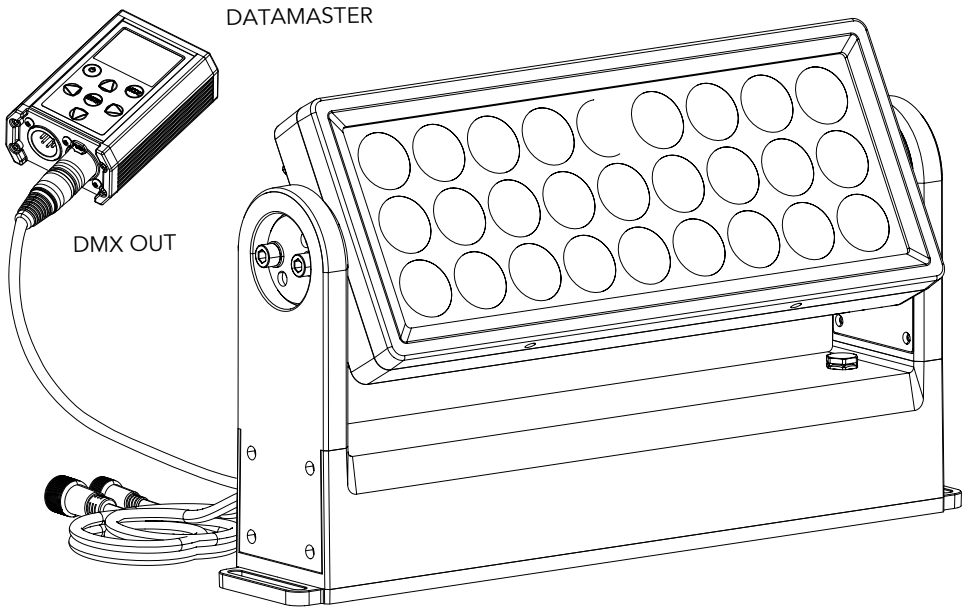

Fig.07

RDM MODE

The RDM mode allows to show information about each connected product, compatible with RDM control protocol. DATAMASTER also allows to change the discovered attributes for the connected fixture. Note: See each individual product's user manual to determine which attributes can be changed via DATAMASTER.

To enter in the RDM mode, use the UP/DOWN buttons to scroll through the menu , then select RDM and press the ENTER button to confirm.

The DATAMASTER will search for connected devices, and you can choose to view by single device or by model, and then show all the attributes and information about the connected fixtures.

Below is the table that corresponds to the menu displayed in RDM mode when you have found a device and then press ENTER on it:

RDM Menu	Menu Level 2	Menu Level 3	Description
Label	<RDM LABEL>		View LABEL for the RDM control.
Model	<FIXTURE MODEL>		View informations about fixture model
Manufactur	<MANUFACTUR>		Product Manufactur
Start Address	001-512		DMX Address, always starts from 001
Personality			To set the DMX mode
DMX Slots			Number of channels for the selected Personality
Slots Options	Slot Description		
	Default Slot Value		
Dimmer Curve	LINER		It is used to choose the Dimmer Curves implemented on the device. (if fixture has this option)
	S-CURVE		
	SQUARE LAW		
	INVERSE SQUARE LAW		
		
Output Response Time	AUTO		It is used to choose the Dimmer Speed implemented on the device.
	FAST		
	MEDIUM		
	SLOW		
		
PWM Modulation	600HZ		To select LED PWM frequency value (Hz) in order to reduce flickering in the process of your camera recordings. (if fixture has this option)
	1200HZ		
	2000HZ		
	4000HZ		
	6000HZ		
	25KHZ		
		
Moving Light Options	Pan Invert		Allows you to reverse Pan movement.
	Tilt Invert		Allows you to reverse Tilt movement.
	Pan Tilt Swap		This allows to swap the control position of the Pan and Tilt control. (For example, channel 1 and channel 2 control Pan and Tilt respectively. After this is set On, channel 1 and channel 2 control Tilt and Pan respectively.)
Power/Lamp Options	Device Hours		To check the total working hours of the unit.
	Lamp Hours		To see the total operating hours of the LED source.
	Lamp Strikes		To see the number of lamp strikes.
	Lamp Slate		To see the current operating state of the lamp.
	Lamp On Mode		Lamp On Mode defines the conditions under which a lamp will be struck.
	Power Cycles		To see the power-up cycles of the machine.

Sensor Menu	TEMPERATURE: --°C		Shows the temperature of all boards: LED, Drivers, etc.
Display Options	Display Invert	Off/On	Allows you to rotate the display by 180°. (if fixture has this option).
	Display Level		Allows you to select the brightness intensity of the display. (if fixture has this option).
Real Time Clock	Year	<year>	If device has real time clock function through this menu you can set year, month, day, hours, minutes, seconds.
	Month	<month>	
	Day	<day>	
	Hour	<hour>	
	Minute	<minute>	
	Second	<second>	
Reset Device	Warm Reset	Yes/No	To Reset the Fixture without powering it off.
	Cold Reset	Yes/No	To reset all electronics, which is equivalent to turning the device off and on again.
Factory Defaults	Get Factory Default	Yes/No	To read the factory values of the Fixture (always returns no).
	Set Factory Default	Yes/No	To set the factory values of the Fixture.
Specific PIDs	ID List	82DD	All RDM PIDs are shown with their numbering. Pressing ENTER opens another page showing: Description of PIDs, the default value, the currently set value, and the line for changing the currently set value. (To see all PIDs values check the fixture manual).
		8211	
		
	Description List	DMS FAULT:0 HOLD:1	
0:MST DMX 1:MST NO DMX 2:SLAVE			
....			
Full On Mode			Full command (usable only on some fixtures).
Model ID	XXXXXXXXXX		Fixture RDM ID model.
SW Version	V1.0.00...		Fixture Firmware Version.
UID	<RDM UID>		Unit identifier number for the RDM control.

AUTO ADDRESS MODE

The AUTO ADDRESS mode allows you to set automatically assign DMX address to the DATAMASTER connected devices.

NOTE: This function is only for ARCSHINE M/S.

STAND ALONE MODE

The STAND ALONE mode allows for standalone settings to dimmer red, green, blue, white LEDs on the fixture.

NOTE: This only for some projectors without display, (ARCPD15Q, ARCPD27Q, ARCPD48Q, ARCPD96Q, ARCPD11). On VW devices this section is not available.

SEND DMX MODE

In SEND DMX mode you can set the values for each of the 512 channels of the DMX line connected to the DATAMASTER, and you can choose to display the values in 0-100 or 0-255 scale. In the same menu you can store the scene with currently set DMX values in different memory locations, reload the stored scenes, and set and play the sequence of stored scenes. The scenes stored in this menu can be also recalled faster in the LOAD SCENE MODE.

RECEIVE DMX MODE

In RECEIVE DMX mode you can read the values for each of the 512 channels of the DMX line connected to the DATAMASTER.

In the same menu you can store the scene with currently read DMX values in different memory locations.

The scenes stored in this menu can be also recalled faster in the LOAD SCENE MODE.

LOAD SCENE MODE

In LOAD SCENE mode the previously stored DMX channel scenes via SEND DMX MODE and RECEIVE DMX MODE can be played.

CABLE TEST MODE

The CABLE TEST mode allows you to test the continuity of each pole in the XLR cable.

Connect the cable to the DATAMASTER unit through the XLR in/out connectors.

To enter the CABLE TEST mode, use the UP/DOWN buttons to scroll through the menu, then select CABLE TEST and press ENTER to confirm.

The DATAMASTER will check the continuity of each pole in the cable.

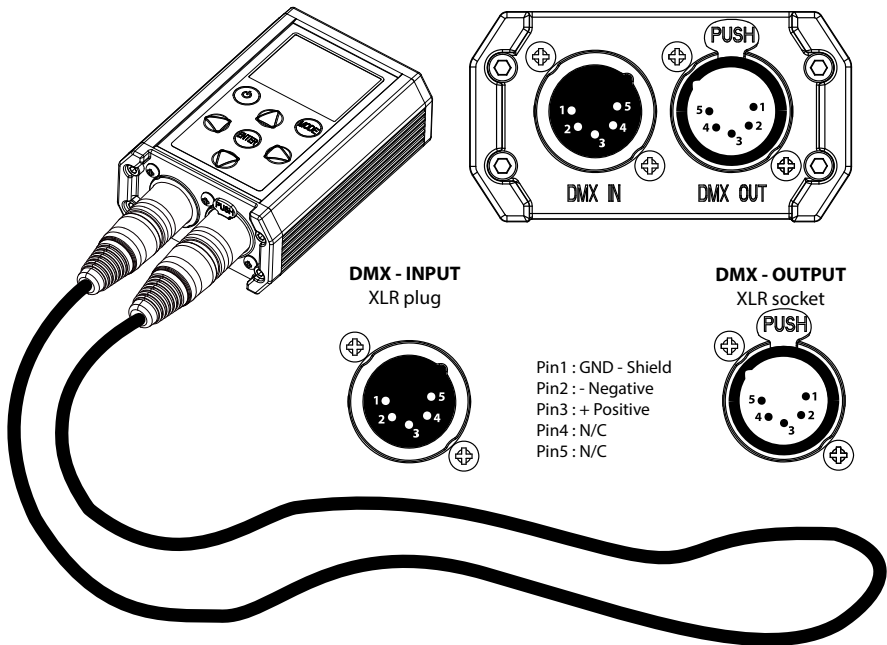

Fig.08

USING EXAMPLE

SET PROLIGHTS™ ARC SHINE S9FC IN STATIC COLOR BY RDM SPECIFIC PIDs

To set the fixture in static color (in this example Prolights Yellow) it's needed to set the unit in STAND ALONE mode (in this example without DMX output from the unit) and then select the desired color.

1. Connect the DATAMASTER to the fixture with DMX cable;
2. Power on the DATAMASTER and the fixture;
3. Enter in RDM menu of DATAMASTER;
4. Select Specific PID in the RDM menu;
5. Set **DMX FAULT** on **STAND ALONE** (PID:0x82DD; Value:2);
6. Set **MASTER NO DMX** (PID:0x8211; Value:1);
7. Set **STAND ALONE** to **MANUAL** (PID:0x82EC; Value:4);
8. Set RGBW static colors as following:
 - Red (PID:0x82C0; Value 255)
 - Green (PID:0x82C1; Value 130)
 - Blue (PID:0x82C2; Value 0)
 - White (PID:0x82C3; Value 0)
9. Quit the RDM menu and power off the DATAMASTER.

9 - MAINTENANCE

MAINTENANCE THE PRODUCT

It is recommended that the product be checked at regular intervals.

- For cleaning use a soft, clean cloth moistened with a mild detergent. Never use a liquid, it might penetrate the unit and cause damage to it.
- The user may also upload firmware (product software) to the fixture via the DMX signal input port and instructions from PROLIGHTS.
- It is recommended to check at least annually if new firmware is available and a visual check of the status of the device and mechanical parts.

WARNING: the use of alcohol or any other detergent could damage the lenses.

- All other service operations on the product must be carried out by PROLIGHTS, its approved service agents or trained and qualified personnel.
- It is PROLIGHTS policy to apply use the best quality materials available to ensure optimum performance and the longest possible component lifetimes. However, components are subject to wear and tear over the life of the product. The extent of wear and tear depends heavily on operating conditions and environment, so it is impossible to specify precisely whether and to what extent performance will be affected. However, you may eventually need to replace components if their characteristics are affected by wear and tear after an extended period of use.
- Use only accessories approved by PROLIGHTS.

VISUAL CHECK OF PRODUCT HOUSING

- The parts of the product cover/housing should be checked for eventual damages and breaking start at least every two months. If hint of a crack is found on some plastic part, do not use the product until the damaged part will be replaced.
- Cracks or another damages of the cover/housing parts can be caused by the product transportation or manipulation and also ageing process may influence materials.

TROUBLESHOOTING

Problems	Possible causes	Checks and remedies
Product doesn't power ON	• No power to the product	• Check if the battery charges possibly charge it.
	• Internal fault	• Contact the PROLIGHTS Service or authorized service partner. Do not remove parts and/or covers, or carry out any repairs or service that are not described in this Safety and User Manual unless you have both authorization from PROLIGHTS and the service documentation.
The product does not communicate properly with the fixtures.	• Bad signal connection	• Inspect connections and cables. Fix eventual bad connections. Repair or replace damaged cables.
	• Signal connection not terminated	• Insert DMX termination plug in signal output socket of the last product on the signal line.
	• Incorrect addressing of the product	• Check the product address and control settings
	• One of the product is defective and is corrupting the signal transmission on the signal line	• Unplug the XLR in and out connectors and connect them directly together to bypass one product at a time until normal operation is regained. Once found the error, have that fixture serviced by a qualified technician.

Contact an authorized service center in case of technical problems or not reported in the table can not be resolved by the procedure given in the table.



PROLIGHTS is a trademark of
MUSIC & LIGHTS S.r.l.
musiclights.it

Via A.Olivetti snc
04026 - Minturno (LT) ITALY
Tel: +39 0771 72190

prolights.it
support@prolights.it